

INSTRUCTION SHEET

CARTER MODEL WCD CARBURETOR

50-378-2

1970 TECHLIT CO.
Printed in U.S.A.

NOTE: Some variations occur in shapes of parts and castings between the various carburetors in this group, although all units are basically alike. (See reverse side for index numbers.)

I. DISASSEMBLY.

a. Using the exploded view on reverse side as a guide, disassemble the carburetor far enough to permit thorough cleaning and inspection of parts. Index numbers on the exploded drawing are in logical order of disassembly.

b. Notice the holes from which the linkage rods are removed so they can be returned to the same locations during reassembly.

II. CLEANING.

NOTE: Do not soak leather, rubber or other parts of this nature in the cleaning solvent.

Soak parts long enough to soften and remove all foreign material. Use a regular carburetor cleaning solvent; lacquer thinner; or denatured alcohol. Use a small brush to aid cleaning, if necessary. Make certain the throttle body is free of hard carbon. Blow out passages in castings with compressed air, and check carefully to insure thorough cleaning of obscure areas.

III. REASSEMBLY.

Reassemble carburetor in reverse of disassembly.

IV. FLOAT LEVEL ADJUSTMENT. (See figure 1.)

With bowl cover held upside down (gasket removed), measure from surface of bowl cover to each float pontoon as indicated in figure 1. (See data table for measurement). Adjust float arm to give desired measurement and center each float to avoid interference in bowl.

Caution: Apply no pressure on the resilient tip needle.

PUMP ADJUSTMENT.

a. Type "A". (See figure 2.) Back out throttle stop screw until throttle valves seat in bores. Install pump link in lower hole of arm. With throttles closed, distance "E" should be as listed in Table. Bend throttle connector rod at lower angle to adjust.

b. Type "B". (See figure 3.) Back out throttle stop screw until throttle valves seat in bores. Pump connector link in outer hole. Hold a straight edge across the top of dust cover housing adjacent

to pump arm, as shown. The flat portion on top edge of pump arm should be parallel to straight edge. Adjust by bending downward connector rod at the upper angle. (Refer to Table.)

VI. METERING ROD ADJUSTMENT.

a. Type "A". (See figure 4.) Back out throttle stop screw until throttle valves seat in bores. Insert metering rod gage, included in kit, in place of either metering rod. Press down on vacuum piston link (lightly) until metering rod pin rests on end of gage. The lug should just touch (not force) the lip, as shown. Adjust by bending the lip on metering rod arm.

b. Type "B". (See figure 2.) Back out throttle stop screw until throttle valves seat in bores. With metering rods in place, press downward on vacuum piston link (B) until metering rods "bottom" in carburetor body. With throttle valves held closed and metering rods "bottomed", loosen clamp screw (A) on metering rod arm and rotate the arm until the lip (C) contacts lug (D) on vacuum piston link. Tighten the clamp screw (A) and recheck.

VII. FAST IDLE ADJUSTMENT.

a. Step "A". (See figure 5.) Loosen the clamp screw in choke lever, place a feeler gage with thickness listed under "Step A" in Table at position (A, figure 5). Hold choke valve tightly closed and remove slack from linkage by pressing down on choke lever lightly; tighten clamp screw in lever. Make sure fast idle adjusting screw is backed out free of fast idle cam.

b. Step "B". (See figure 6.) With choke valve held closed and end of fast idle screw (C) resting on high step of fast idle cam (B), rotate screw (C) until the dimension listed under "Step B" in the Table exists between edge of throttle valve and carburetor bore. Measure at side opposite idle port.

VIII. UNLOADER ADJUSTMENT. (See figure 6.)

Open the throttle valves wide and measure the clearance between lower edge of choke valve and air horn wall. Bend the unloader lip until this clearance is as listed in the Table.

IX. IDLE ADJUSTMENT. (See figure 7.)

Adjust throttle stop screw (1) to crack throttle valves slightly. Start and warm up engine. Adjust mixture screws (2) until engine idles smoothly. Readjust throttle stop screw (1) to idle engine at between 450 and 500 rpm. Then readjust mixture screws (2) if necessary.

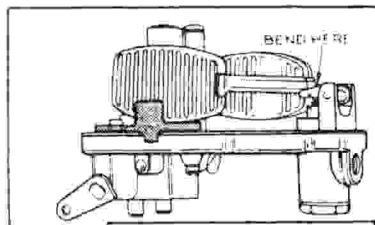

Figure 1

CAUTION
DO NOT EXERT PRESSURE
ON RESILIENT NEEDLE
VALVE.

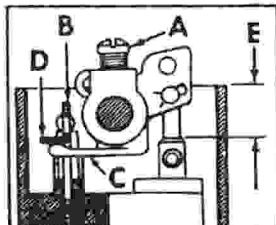

Figure 2

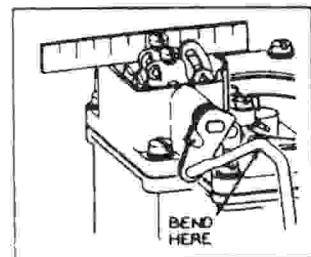

Figure 3

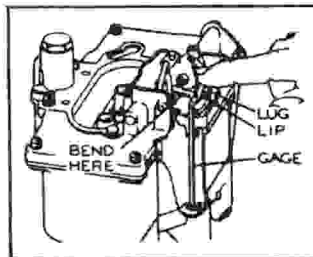

Figure 4

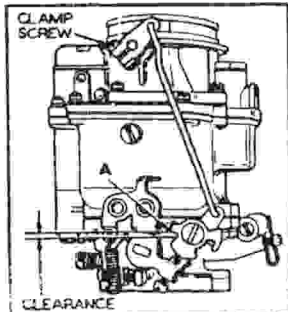

Figure 5

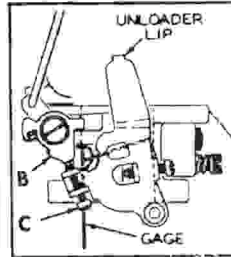

Figure 6

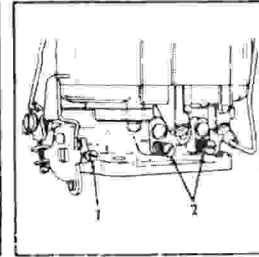

Figure 7

ADJUSTMENT DATA TABLE

Year & Make	Float Level	PUMP ADJ.		METERING ROD ADJ.		FAST IDLE ADJ.		UNLOADER
		Type	Setting	Type	Setting	Step A	Step B	
1945-47 Buick M40-50	3/16	A	21/64	A	2.44	.020	.012	3/16
1945-47 Buick M-70	3/16	A	21/64	A	2.54	.020	.018	3/16
1948-49 Buick M40-50-70	5/32	A	21/64	B	Bottom	.020	.018	3/16
1950-53 Buick M-40	5/32	A	70/64	B	Bottom	.020	.015	3/16
1950-53 Buick M-50	5/32	A	20/64	B	Bottom	.020	.015	3/16
1950-51 Buick M-70	5/32	A	20/64	B	Bottom	.020	.015	3/16
1953 Buick M50	7/32	A	17/64	B	Bottom	.020	.015	3/16
1954 Buick M40-50	7/32	A	17/64	B	Bottom	.020	.028	3/16
1955 Buick M40 Early & Canada	3/16	A	17/64	B	Bottom	.020	.025	1/8
1950-51 Cadillac	5/32	A	19/64	B	Bottom	.020	.020	7/32
1953-54 Pontiac 6	5/32	B	Parallel	B	Bottom	.040	.026	9/64
1947-48 Pontiac 8	3/16	A	18/64	A	2.94	.040	.026	1/8
1949-54 Pontiac 8	3/16	A	20/64	A	2.94	.040	.026	1/8
1955-63 Rambler	5/32	B	Parallel	B	Bottom	.010	.020	3/16
1964-65 Rambler 196" Eng.	1/8	R	Parallel	B	Bottom	.010	.020	3/16
*1965-67 American Mtrs. 232" Eng. & W/Air Guard	1/4"	D	Parallel	B	Bottom	.010	.020	3/16
1967-70 American Mtrs. 232" Eng. W/Engine Mod. System	7/32"	B	Parallel	B	Bottom	.010	.020	3/16
1954-56 Willys 6-226 Eng.	3/16"	B	Parallel	B	Bottom	.010	.020	3/16"

*1965 Brass or Black Tags Set Float Level 1/8"

PARTS LIST
CARTER MODEL WCD CARBURETOR

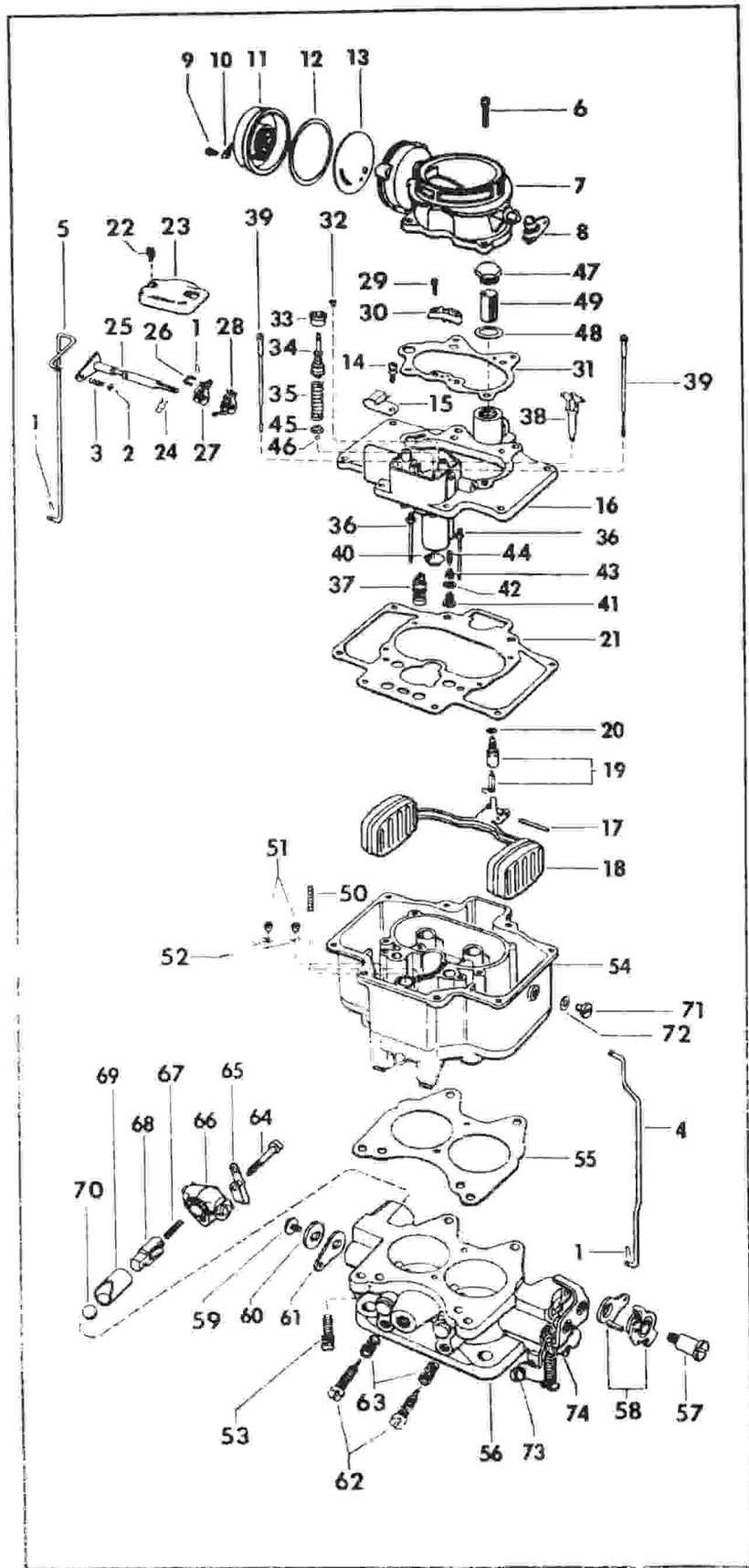

Ref. No.

NOMENCLATURE

1	Spring - Pin
2	Retainer - Pump spring
3	Spring - Connector rod
4	Rod - Choke connector
5	Rod - Throttle connector
6	Screw and Lock Washer Assembly
7	Air Horn Assembly
8	Lever Assembly - Choke
9	Screw - Coil housing
10	Retainer - Coil housing
11	Housing Assembly - Thermostat
12	Gasket - Coil housing
13	Plate - Choke baffle
14	Screw and Lock Washer Assembly
15	Clip - Cable
16	Cover Assembly - Bowl
17	Pin - Float
18	Float Assembly
19	Needle and Seat Assembly
20	Gasket - Needle seat
21	Gasket - Bowl cover
22	Screw and Lock Washer Assembly
23	Cover - Dust
24	Spring - Pin
25	Lever - Pump operating
26	Link - Pump arm
27	Arm Assembly - Pump
28	Arm Assembly - Metering rod
29	Screw and Lock Washer Assembly
30	Jet Assembly - Pump
31	Gasket - Air horn
32	Screw - Pump plunger guide
33	Guide - Pump plunger
34	Plunger Assembly - Pump
35	Spring - Pump plunger
36	Jet - Low speed
37	Piston - Vacuum
38	Link - Vacuum piston
39	Rod - Metering
40	Strainer - Pump
41	Check - Pump discharge relief
42	Gasket - Pump discharge needle
43	Seat - Pump discharge needle
44	Needle - Pump check
45	Retainer - Intake ball check
46	Ball - Pump intake check
47	Nut - Strainer
48	Gasket - Strainer nut
49	Strainer
50	Spring - Vacuum piston
51	Jet - Main metering
52	Gasket - Main metering jet
53	Screw and Lock Washer Assembly
54	Main Body
55	Gasket - Flange
56	Throttle Body
57	Screw - Fast idle cam
58	Cam Assembly - Fast idle
59	Screw - Throttle shaft arm
60	Washer - Throttle shaft
61	Arm - Throttle shaft
62	Screw - Idle adjusting
63	Spring - Idle adjusting screw
The following parts are not used on all models.	
64	Screw - Switch terminal
65	Clip - Holddown
66	Cap Assembly - Switch terminal
67	Spring - Switch return
68	Block - Switch guide
69	Plunger - Switch
70	Ball - Switch
71	Plug - Fuel level
72	Gasket - Fuel level plug
73	Screw - Throttle stop
74	Screw - Fast idle adjusting
	Gage - Metering rod